

ONE GOAL, ONE DREAM - MISSION SELECTION 2024

PREMIUM BUNDLE PDF COURSE 2024

Highlighting Segments

- Beginners Bundle Quiz Course
- Topic-Wise Bundle Course
- Exam-Wise Bundle PDF Course
- Section-Wise Bundle PDF Course
- Memory Based Questions Bundle Course
- Prelims Scoring Part Bundle Course
- Mains Booster Bundle Course
- Critical Reasoning Bundle Course
- Mains Two Mark Questions Bundle Course
- Daily Editorial Based English Questions PDF
- Special Quants Arithmetic Bundle Course
- Special DI & Caselet Bundle Course
- Special Puzzles & Seating Bundle Course
- 101 Version 2.0 New Pattern Puzzles & DI Questions
- Current Affairs Bundle PDF Course
- Static Banking & Static GK Bundle Course
- Computer Awareness Bundle Course

*Special Offer For **PRIME** Users

One Time Offer Ends Soon - Hurry!!!

GRAB IT NOW

[Click Here For Bundle PDF Course](#)

[Click Here to Subscribe Our Yearly Mock Test Package](#)

Linear Seating Arrangement for Bank Exam – Question Bank Set 1 (Eng)

Directions (1-5): Study the following information carefully and answer the below questions.

Eight people P, Q, R, S, T, U, V and W are sitting in a linear row and facing south direction.

V sits three places away from U who sits two places away from R. P sits third to the right of R.

Q sits second to the right of S who sits an immediate neighbour of P. The number of persons who sits to the right of W is one more than the number of persons who sits to the left of V. Neither R nor U sits adjacent to T.

1) Who sits fourth to the left of S?

- A. W
- B. U
- C. R
- D. V
- E. None of these

2) Who sits exactly between T and the person who sits second to the right of W?

- A. Q
- B. W
- C. V
- D. None
- E. None of these

3) Which of the following statement is/are true with respect to V?

- I. T sits second to the right of V
 - II. More than four persons sit between V and R
 - III. P sits exactly between W and V
- A. Only III

- B. Both I and II
- C. Both I and III
- D. All I, II and III
- E. None of these

4) If all the persons arranged in alphabetical order from right to left, how many persons remain unchanged in their position?

- A. None
- B. One
- C. Two
- D. Three
- E. More than three

5) In which of the following statement the first person sits exactly between the third and the second person in the following arrangement?

- I. SUV
 - II. PRQ
 - III. VTU
- A. Only II
B. Only III
C. Only I and III
D. All I, II and III
E. None of these

Direction (6-10): Study the following information carefully and answer the questions given below.

Eight persons - P, Q, R, S, T, U, V and W are sitting in a linear row such that all of them are facing towards the south, but not necessarily in the same order.

Linear Seating Arrangement for Bank Exam – Question Bank Set 1 (Eng)

W sits third to the left of R. Neither R nor W sits at the extreme ends of the row. Only three persons sit between R and U. P sits second to the right of U. The number of persons sitting to the right of S is one less than the number of persons sitting to the left of T. V is an immediate neighbour of T. V does not sit at any of the extreme ends of the row.

6) Who among the following person sits second to the right of T?

- A. W
- B. The one who sits second to the right of P
- C. Q
- D. The one who sits immediate left of R
- E. None of these

7) What is the position of P with respect to S?

- A. Immediate left
- B. Third to the right
- C. Fourth to the left
- D. Second to the right
- E. Immediate right

8) If Q is related to T and V is related to R in a certain way, then who among the following person is related to P?

- A. S
- B. W
- C. R
- D. T
- E. None of these

9) Who among the following pair of persons sit adjacent to R?

- A. V and S
- B. P and T
- C. Q and V
- D. T and S
- E. None of these

10) Who among the following person sits immediate left of the one who sits third to the right of S?

- A. W
- B. The one who sits third to the left of V
- C. Q
- D. The one who sits second to the right of S
- E. R

ANSWER WITH EXPLANATION

Directions (1-5):

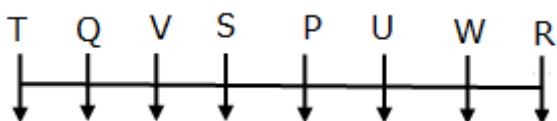

1) Answer: C

2) Answer: C

3) Answer: C

4) Answer: D

5) Answer: A

P sits third to the right of R. V sits three places away from U who sits two places away from R

Linear Seating Arrangement for Bank Exam – Question Bank Set 1 (Eng)

Case I

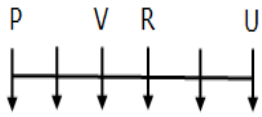

Case II

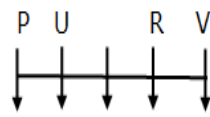

Case IIa

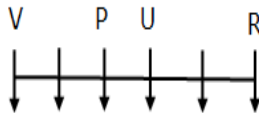

Q sits second to the right of S who is an immediate neighbour of P.

Case I

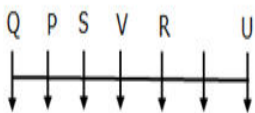

Case II

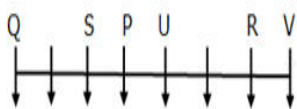

Case IIa

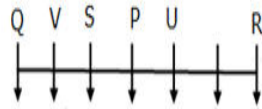

The number of persons who sits to the right of W is one more than the number of persons who sits to the left of V. Neither R nor U sits adjacent to T.

~~Case I~~

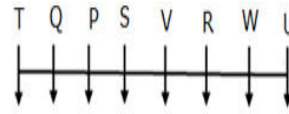

~~Case II~~

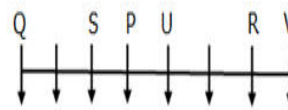

Case IIa

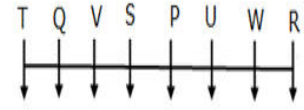

Direction (6-10):

6) Answer: C

7) Answer: A

8) Answer: C

9) Answer: D

10) Answer: D

Final Arrangement:

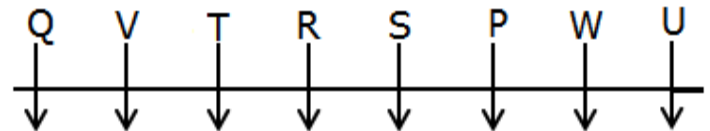

We have,

- W sits third to the left of R.
- Neither R nor W sits at the extreme ends of the row.
- Only three persons sit between R and U.

From the above condition, there are three possibilities.

Linear Seating Arrangement for Bank Exam – Question Bank Set 1 (Eng)

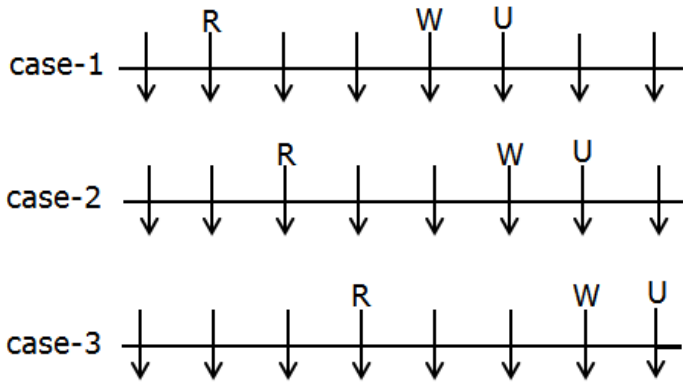

Again we have,

- P sits second to the right of U.
- The number of persons sitting to the right of S is one less than the number of persons sitting to the left of T.

From the above condition, case-2 gets eliminated.

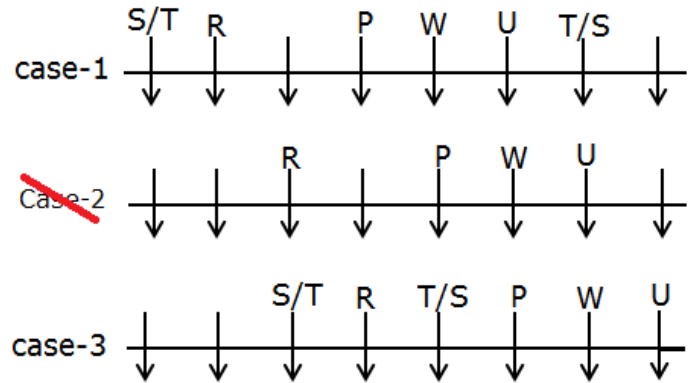

Again we have,

- V is an immediate neighbour of T.
- V does not sit at any of the extreme ends of the row.

So case-1 gets eliminated, hence the final arrangement becomes

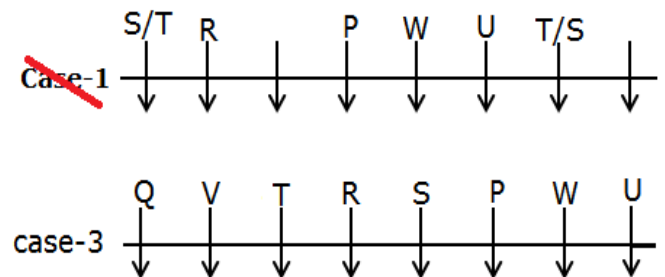

[Click Here For Bank Exam Free PDF](#)

[Click Here For Reasoning Free PDF](#)

[Click Here For Quantitative Aptitude Free PDF](#)

[Click Here For English Free PDF](#)